



Colonial Aluminum[®]



Colonial
ALUMINUM[®]

Classically Styled Aluminum Fencing





Colonial Aluminum Fencing

There are two families of Colonial Aluminum Fencing. Standard Colonial offers 5/8" pickets, Colonial Plus offers 3/4" pickets.

Colonial Aluminum® fences offer a variety of design styles to customize the look of your property. All panels come in rackable sections, which beautifully adjust to the contours of most landscapes. They also offer the beauty of a screwless design for that desired "good neighbor" look.

Colonial Aluminum fences are an attractive ornamental fence with the classic look of wrought iron, and the low maintenance of aluminum. The added benefit of a Lifetime Limited Warranty provides the peace of mind in knowing your investment will last for years to come.

Features & Benefits

- Aluminum panels and posts that never develop red rust, cost less to maintain, and are ideal for poolside installations
- Easy rackability over uneven terrain
- Durable Polyester TGIC powder coating resists fading and scratches for a lasting look
- Architectural grade powder coating meets or exceeds AAMA 2603 specifications
- Screwless panels for a clean "good neighbor" look
- Gates have welded rails and pickets for added strength and durability
- Assembled sections for quick and easy installation
- Lifetime Limited Warranty
- Many styles available to suit your needs: Universal, Spear, Universal Spear, Picket, and Staggered Spear
- Made in the USA
- Colonial Plus offers punch post or bracket installation

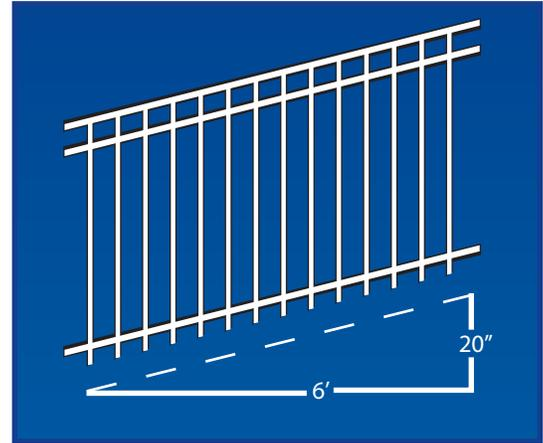

Colonial fencing adjusts 20 inches over 6 feet

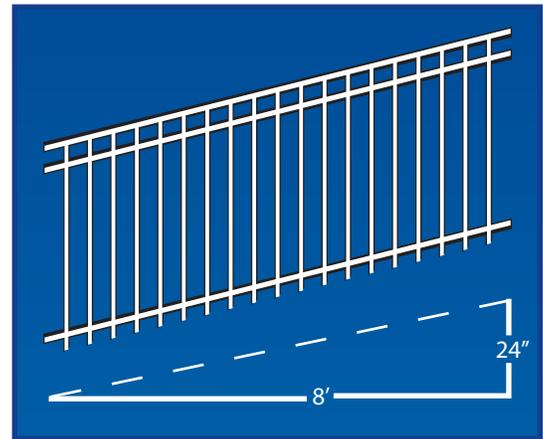

Colonial Plus fencing adjusts 24 inches over 8 feet

New



Colonial PLUS
ALUMINUM™

Feature

Brackets or punch post using same panel

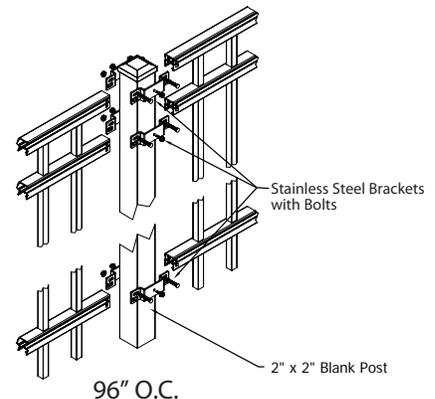
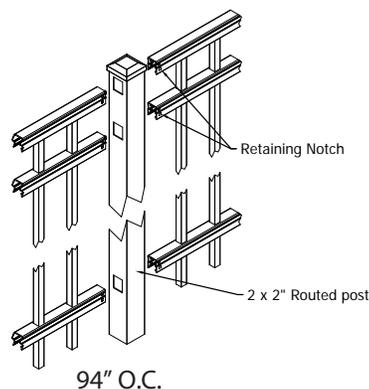

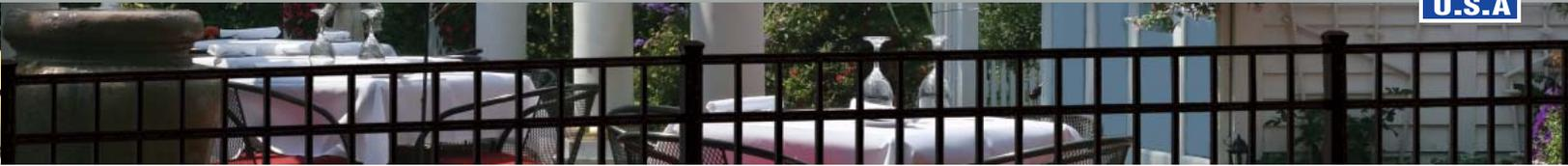

11 Step Powder Coating Process

Pre-treatment

All Colonial Aluminum® fences are given a 9-step pre-treatment process that cleans and prepares the aluminum to assure complete adhesion of the powder coating.

Step 1 Our raw premium grade aluminum is inspected to be free of blemishes and is not exposed to outdoor elements.

Step 2 Product enters heated alkaline cleaner stage to remove extrusion and fabrication oils.

Step 3 City water rinse.

Step 4 Recycling reverse osmosis water rinse.

Step 5 Pure reverse osmosis water rinse.

Step 6 Primer/sealer conversion coating which provides a strong adhesion of coating to the aluminum.

Step 7 Pure reverse osmosis water rinse. Final rinse is of the same quality as bottled drinking water. Clean water removes contaminants which will hinder coating performance.

Step 8 A 200 MPH air blast removes water drops from the pre-treated product.

Step 9 A convection oven completes the dry-off process for a clean dry surface to powder coat.

Powder Coating

Step 10 Powder application is automated. Compressed process air is dried to -35°F Dew Point for superior adhesion and aesthetics. The powder booth contains powder coating overspray with no emissions to the surrounding environment.

Step 11 The final step of the powder coating process is the cure oven where the powder coating gels and bonds to the aluminum.

Testing

Ten pre-treat system titration checks twice per shift maintain system parameters, and ten QC checks are completed every hour on product coming off the production line.

Automated Chemical Test – Pre-treatment chemicals are monitored and added automatically

System Titration Test – Ph levels are checked twice per shift as part of the pre-treatment titration testing

Cure Oven Temperature Test – Ensures proper curing of powder coating

Coating Thickness Test – Coating thickness is measured and plotted every hour

ASTM D3359 Crosshatch Test – Hourly crosshatch testing is done to test coating adhesion

PCI#8 Solvent Cure Test – Solvent testing is completed every hour to test for complete cure



When you're searching for a great value in an elegant fence, Colonial Aluminum® provides you a wide variety of styles to choose from. Their lasting beauty and easy installation are combined with quality construction and outstanding durability.



Universal

1" Rails & 5/8" Pickets

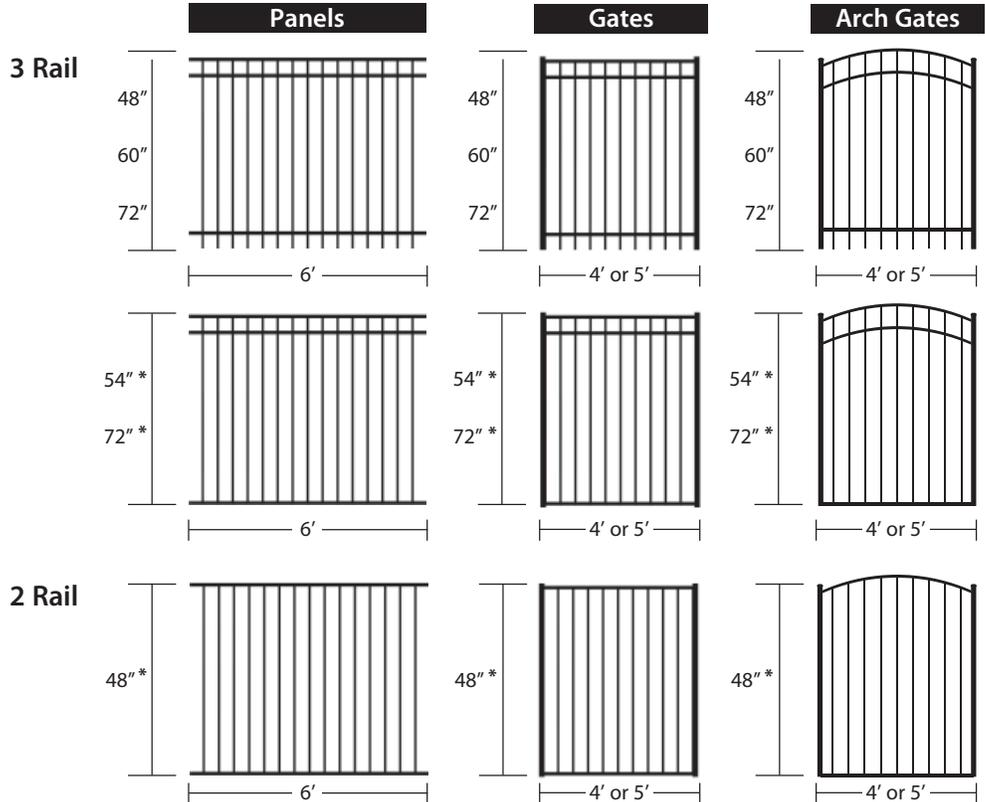

Universal Spear

1" Rails & 5/8" Pickets

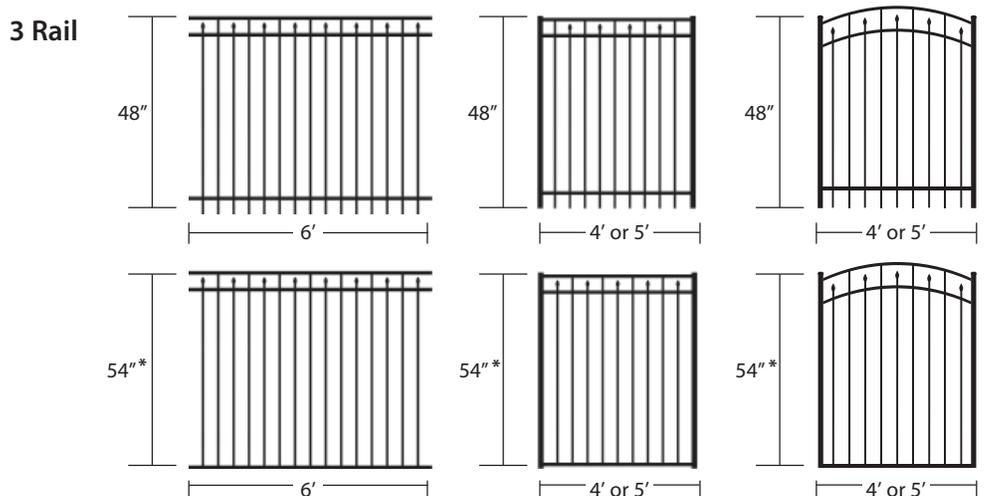

Colonial Panels & Gates

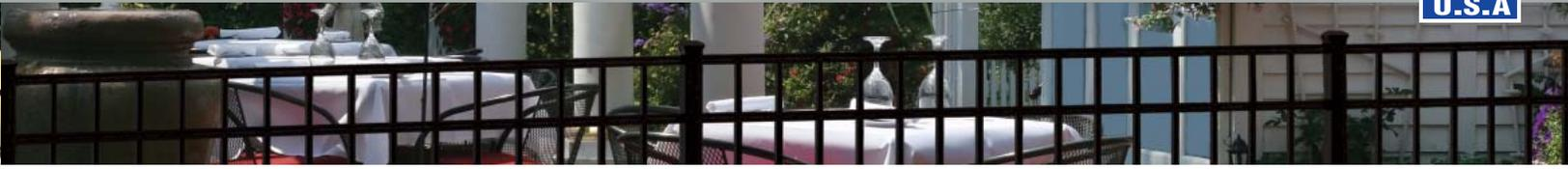

Spear

1" Rails & 5/8" Pickets

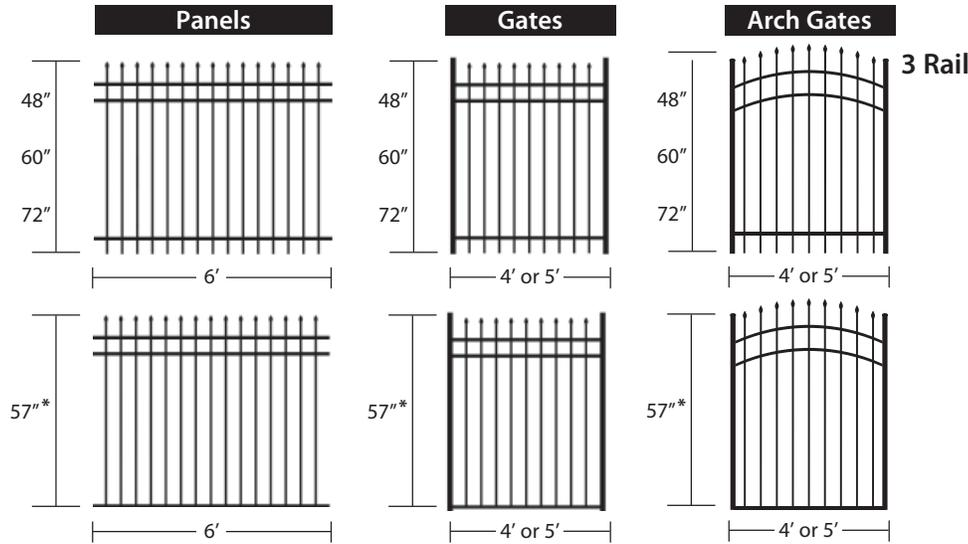

Staggered Spear

1" Rails & 5/8" Pickets

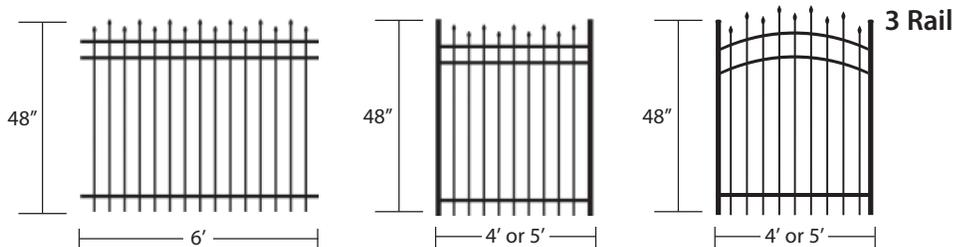

Picket

1" Rails & 5/8" Pickets with Aluminum Picket Plugs Pre-Installed

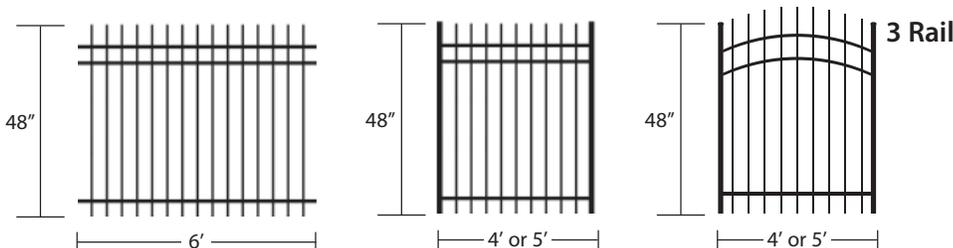

* Panel/Gate meets **1993 BOCA pool code**. Check local pool enclosure codes for compliance. Panel/Gate height includes 2 inches clearance between finished ground level and the panel/gate.

Other items and sizes may be available through our special order program. See your local MasterHalco branch representative for availability and leadtime. Check, MasterHalco.com, for the latest complete product information and specifications.

Colonial Aluminum®
fencing surrounds your property with a secure structure that requires very little maintenance. Its lasting looks come with the peace of mind of a Lifetime Limited Warranty making Colonial Aluminum fencing an excellent choice.





Colonial Plus aluminum

fencing provides

durability, strength

and lasting beauty in

a variety of structures

and styles that will

compliment your

landscape. The 3/4"

pickets add that special

touch of security.



Universal

1-1/2 x 1-1/4" Rails & 3/4" Pickets

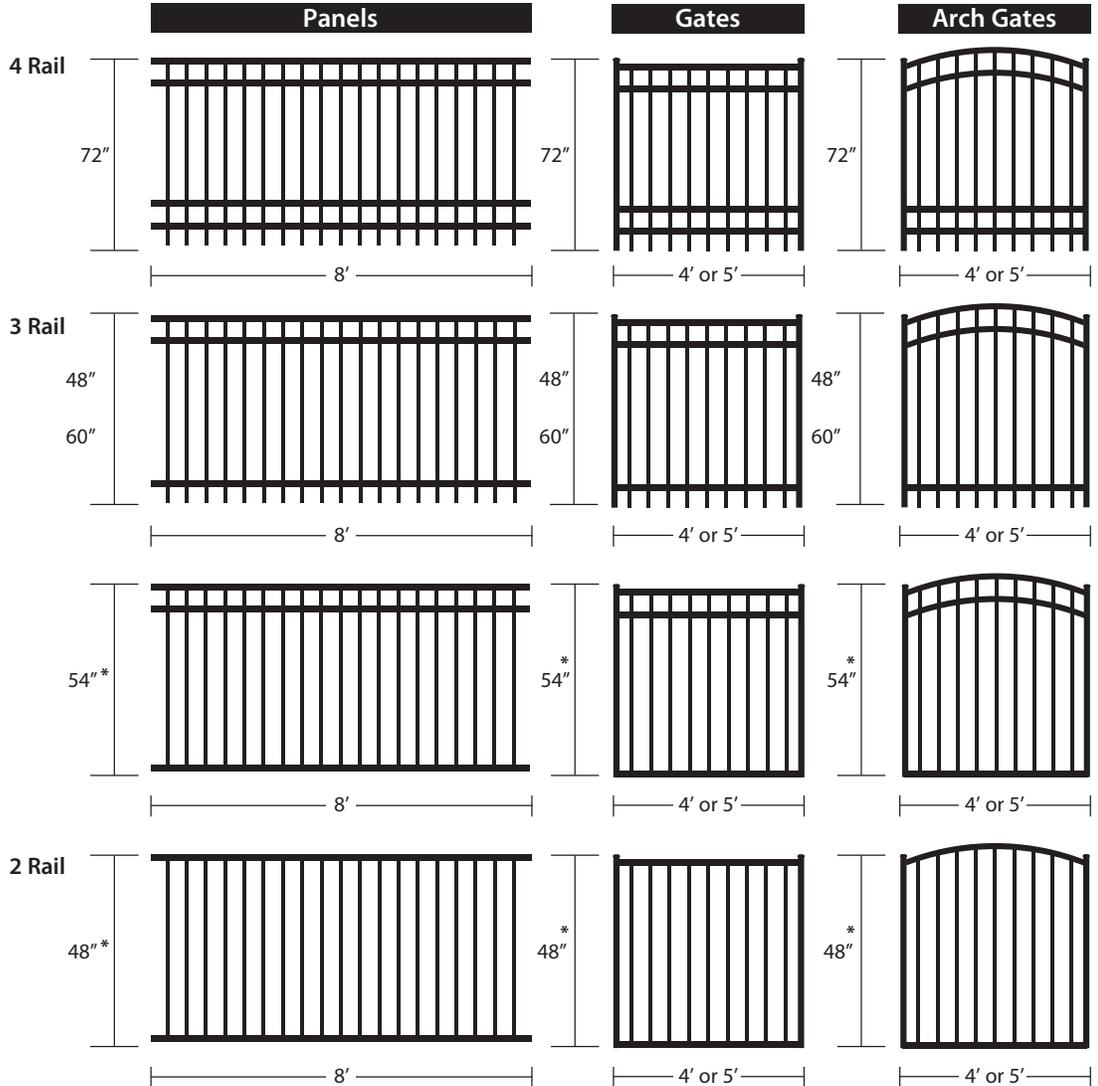

**NEW
PRODUCT**



Colonial PLUS
ALUMINUM®

Colonial Plus Panels & Gates



Universal Spear

1-1/2 x 1-1/4" Rails & 3/4" Pickets

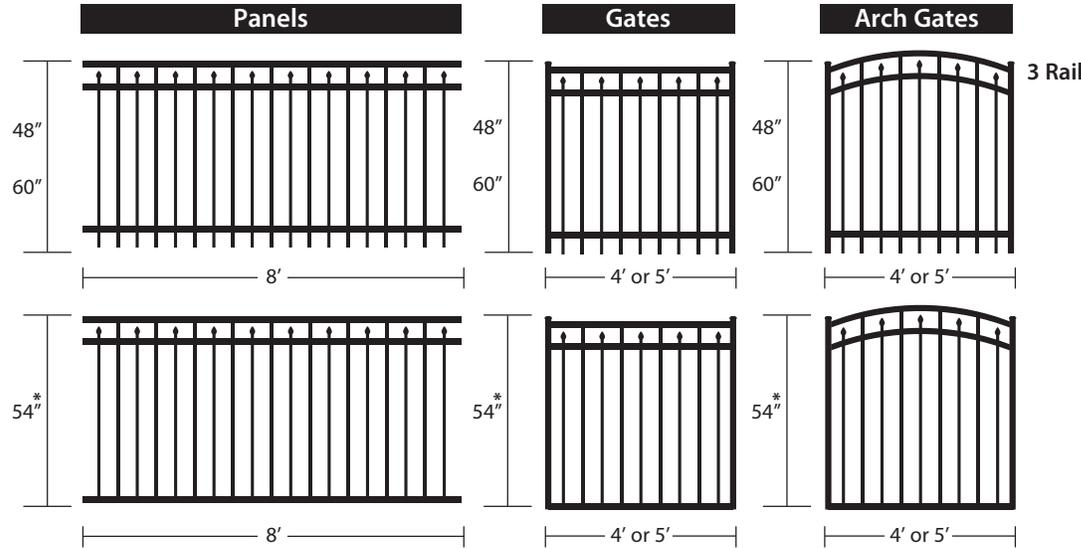

Spear

1-1/2 x 1-1/4" Rails & 3/4" Pickets

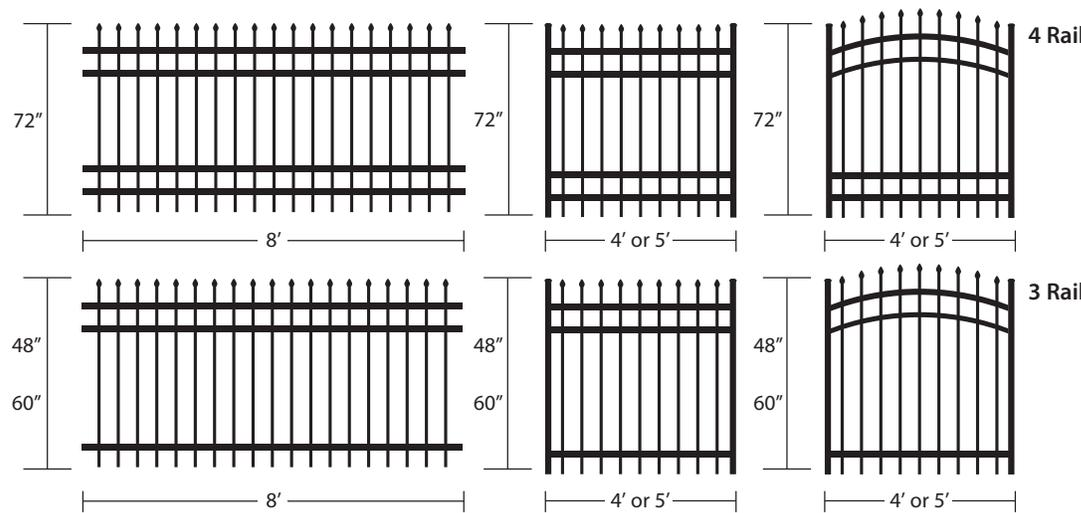

Low maintenance

aluminum construction

combined with a unique

post and bracket design

makes assembly and

installation simple for a

seasoned installer or the

"do it yourself" property

owner.



**NEW
PRODUCT**



Colonial PLUS
ALUMINUM®

* Panel/Gate meets **1993 BOCA pool code**. Check local pool enclosure codes for compliance. Panel/Gate height includes 2 inches clearance between finished ground level and the panel/gate.

Other items and sizes may be available through our special order program. See your local Master Halco branch representative for availability and leadtime. Check, MasterHalco.com, for the latest complete product information and specifications.

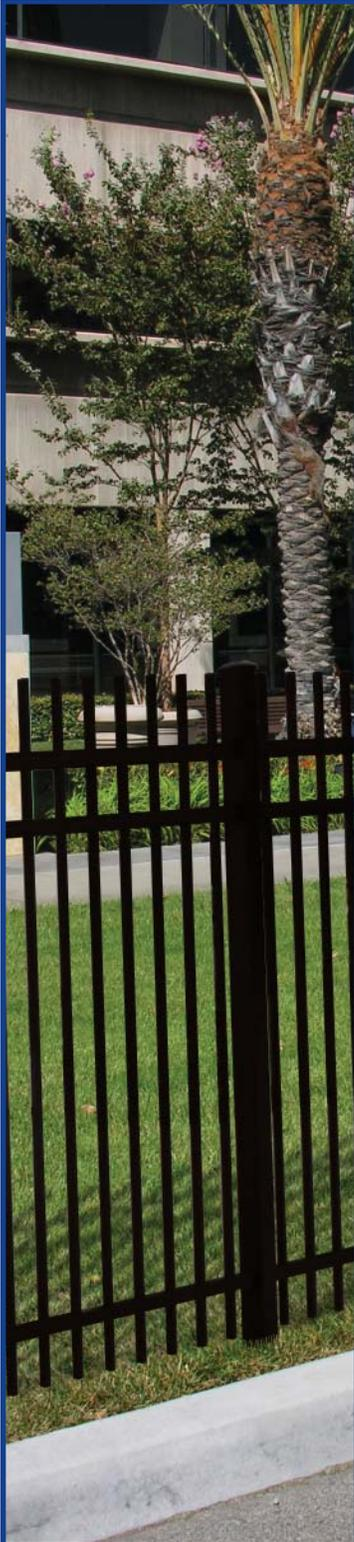

Staggered Spear

1-1/2 x 1-1/4" Rails & 3/4" Pickets

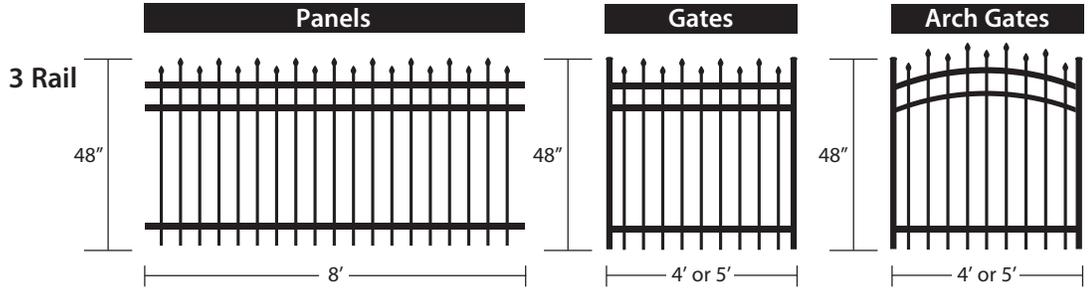

Picket

1-1/2 x 1-1/4" Rails & 3/4" Pickets with Aluminum Picket Plugs Pre-Installed

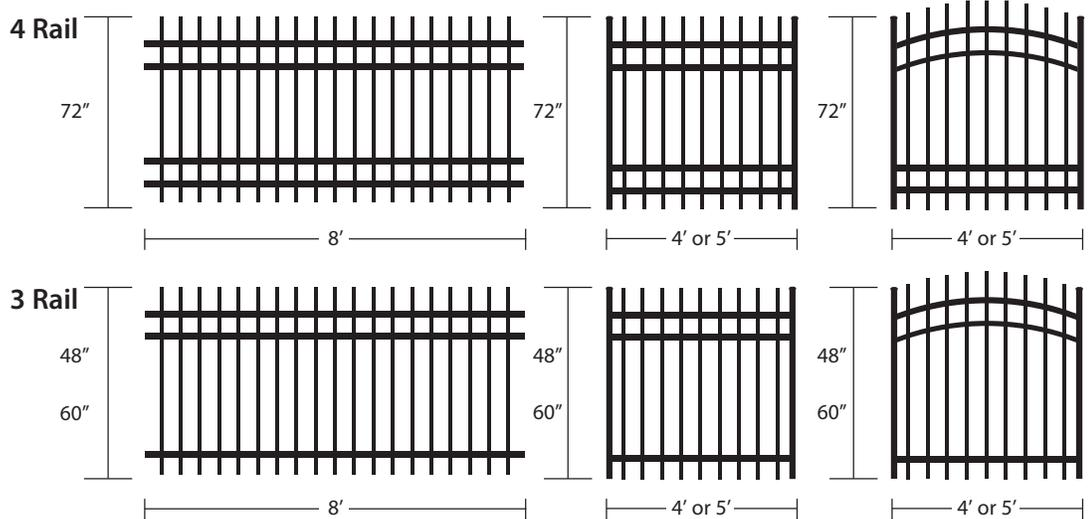

**NEW
PRODUCT**



Colonial PLUS
ALUMINUM®

Note: Other items and sizes may be available through our special order program. See your local Master Halco branch representative for availability and leadtime.

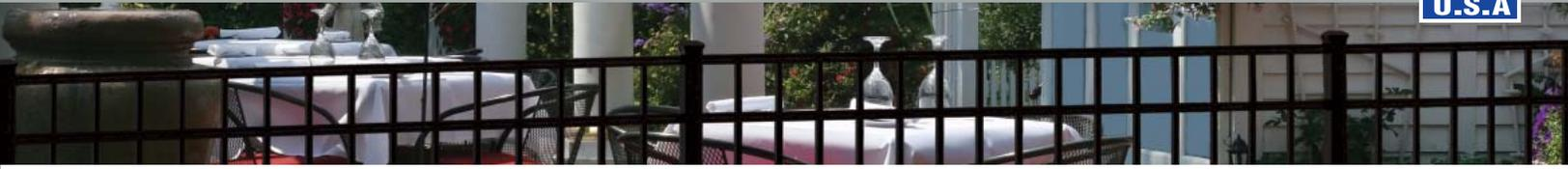

Mounts and Brackets

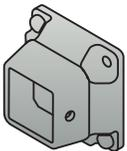
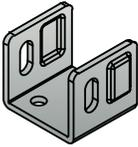
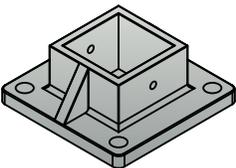
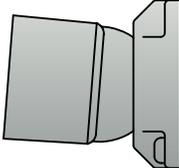
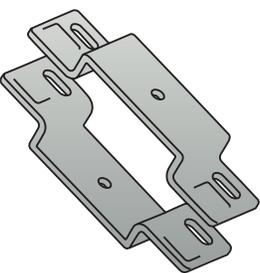
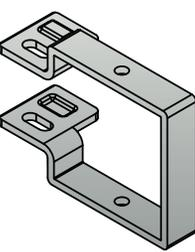
					
Colonial Wall Mount	Colonial Plus Wall Mount				
Wall Mounts		Post Mount	Swivel Rail Mount	Line Bracket	Universal Bracket
+		+	+	+	+

Caps and Finials

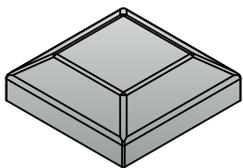
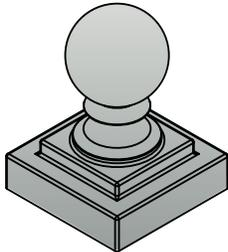
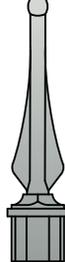
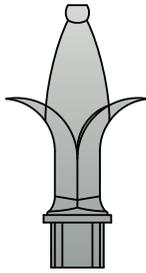
				
Flat Cap	Ball Cap	Fleur-de-lis Finial	Quad Finial	Triad Finial
+	+	+	Available pre-installed on special order for Colonial	
			+	+

Tools and Repair

Rings

Drop Rod

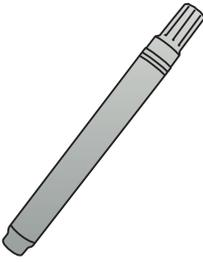
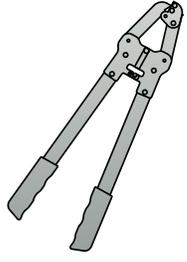
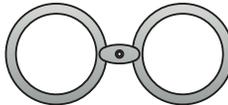
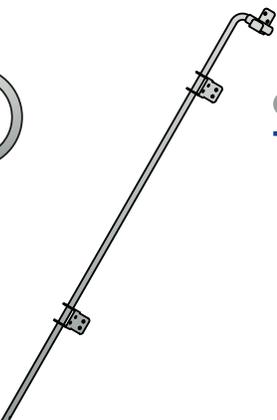
				
Touch Up Paint Pen	Touch Up Paint Can	Field Notch Tool		
+	+	+	+	+

○ Accessories that work with the Colonial Fencing System
 + Accessories that work with the Colonial Plus Fencing System



Colonial Posts

Style	Length			
	78"	84"	90"	102"
Universal & Universal Spear	x		x	x
Universal Flat Bottom	x	x		x
Spear & Staggered Spear	x		x	x
Picket	x		x	x
Blank (.06 and .125)	x	x	x	x



Colonial Plus Posts

Style	Length					
	78"	84"	90"	96"	102"	108"
Universal & Universal Spear	x		x	x		
Universal Flat Bottom	x	x				
Spear & Staggered Spear	x		x		x	
Picket	x		x		x	
Blank (.09 wall)	x	x	x		x	
Blank (.125 wall)	x	x	x	x	x	x
Blank (.250 wall)		x		x		x

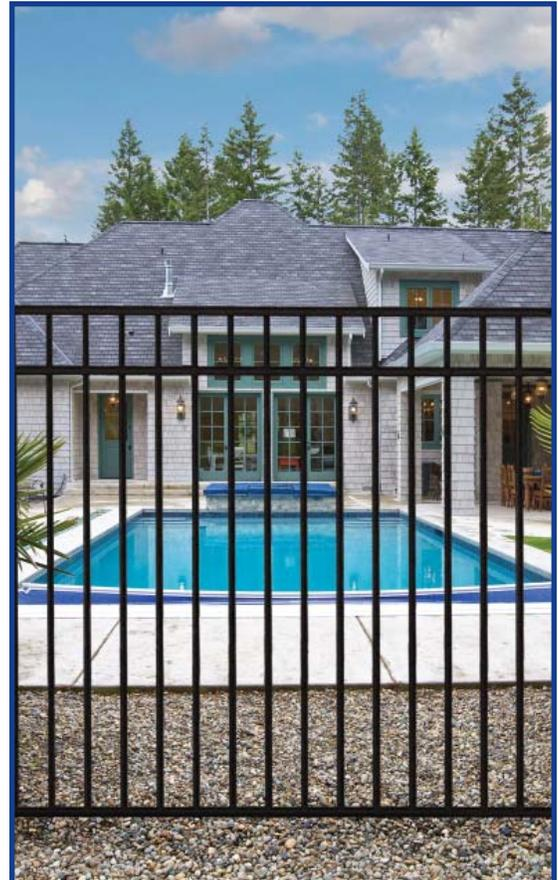

Available Colors



Black

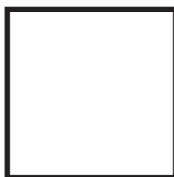

White



Bronze

Specifications

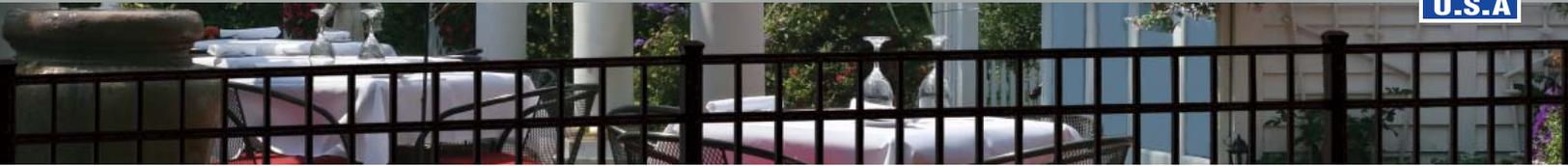

1.1 SCOPE:

This specification covers materials and construction requirements for Colonial and Colonial Plus Aluminum® Fence.

1.2 MATERIALS:

1.2a COLONIAL 5/8" PICKET

A. PICKETS: 5/8" x 5/8" square, .045" wall thickness, 6063 T52 aluminum tubular members, having an ultimate tensile strength of at least 26,000 psi (152 MPa) and yield strength of at least 20,000 psi (110 MPa). Space pickets 3.792" face to face.

B. RAILS: 1" W (.055 wall thickness) x 1" H (.082 wall thickness), 6063 T6 aluminum "U" channel, having an ultimate tensile strength of at least 30,000 psi (207 MPa) and yield strength of at least 25,000 psi (172 MPa).

C. POSTS: 2" x 2" square, .060" wall thickness, 6063 T6 aluminum tubular members, having an ultimate tensile strength of at least 30,000 psi (207 MPa) and yield strength of at least 25,000 psi (172 MPa).

D. GATE POSTS: 2" x 2" square, .125" wall thickness, 6063 T6 aluminum tubular members, having an ultimate tensile strength of at least 30,000 psi (207 MPa) and yield strength of at least 25,000 psi (172 MPa).

E. POST CAPS: 2" x 2", flat, aluminum die cast. 2" x 2", ball, aluminum die cast.

1.2b COLONIAL PLUS 3/4" PICKET

A. PICKETS: 3/4" x 3/4" square, .053" wall thickness, 6063 T52 aluminum tubular members, having an ultimate tensile strength of at least 22,000 psi (152 MPa) and yield strength of at least 16,000 psi (110 MPa). Space pickets 3.938" face to face.

B. RAILS: 1.25"W (.065 wall thickness) x 1.5"H (.075 wall thickness), 6063 T6 aluminum "U" channel, having an ultimate tensile strength of at least 30,000 psi (207 MPa) and yield strength of at least 25,000 psi (172 MPa).

C. POSTS: 6063 T6 aluminum tubular members, having an ultimate tensile strength of at least 30,000 psi (207 MPa) and yield strength of at least 25,000 psi (172 MPa). The size and wall thickness are listed below:

Post Type	Size	Wall Thickness
Line, End, Corner, Blank	2.5"	.09"
Gate, Blank	2.5"	0.125"
Blank	3"	0.125"
Blank	4"	0.250"

D. POST CAPS: 2.5" x 2.5", flat, aluminum die cast. 2.5" x 2.5", ball, aluminum die cast.

E. Brackets: 2.5" & 3" Universal, 2.5" & 3" Line, Wall and Swivel brackets. Cast Aluminum.

F. Finials: Cast Aluminum

1.3 ASSEMBLY:

A. All panels are pre-assembled with nylon screwless fasteners.

B. Rails are notched for screwless installation.

1.4 COATING:

Colonial Aluminum fencing utilizes polyester powder coating that will meet or exceed AAMA 2603-03 specifications. All fence sections and components are given an 9-step pre-treatment process that cleans and prepares the aluminum to assure complete adhesion of the powder coating.

Step 1 - Raw aluminum is inspected to be free of blemishes and is not exposed to outdoor elements.

Step 2 - Product enters heated alkaline cleaner stage to remove extrusion and fabrication oils.

Step 3 - City water rinse.

Step 4 - Recycling reverse osmosis water rinse.

Step 5 - Pure reverse osmosis water rinse.

Step 6 - Primer/sealer conversion coating, which provides a strong adhesion of coating to the aluminum.

Step 7 - Pure reverse osmosis water rinse. Final rinse is of the same quality as bottled drinking water. Clean water removes contaminants which will hinder coating performance.

Step 8 - A 200 MPH air blast removes water drops from the pre-treated product.

Step 9 - A convection oven completes the dry-off process for a clean dry surface to powder coat.

Powder application is automated. Compressed process air is dried to -35°F Dew Point for superior adhesion and aesthetics. The powder booth contains powder coating overspray with no emissions to the surrounding environment.

The final step of the powder coating process is the cure oven where the powder coating gels and bonds to the aluminum.

COLOR- Black, white or bronze. Other colors are available on special order.

1.5 WARRANTY:

Provide Master Halco's lifetime limited warranty that its ornamental fence system is free from defects in material or workmanship including cracking, peeling, blistering and rust. The Lifetime Limited Warranty applies only to living entities. Non-living entities shall include but not be limited to governments, municipalities, corporations, and commercial operations. All non-living entities shall receive a 30-year limited warranty from the date of purchase. This Limited Warranty applies only to systems constructed entirely of components manufactured and/or supplied by Master Halco.



Full Fencing Solutions

Master Halco distributes a broad range of fencing solutions for commercial and residential applications, including:

- Chain-link
- Ornamental fence (steel & aluminum)
- Welded wire
- Wood
- PVC
- Composite

For more information about Master Halco products and services, call **1.888.MH.FENCE** toll-free or visit us online at www.masterhalco.com.



Heritage & Commitment

Master Halco is the master of security, innovation and style. As North America's leading manufacturer and wholesale distributor of fencing systems, we are the provider of choice for thousands of professional fence and security contractors and quality building material retailers. Since 1961, we have been the industry's premier fencing provider.



A Tradition of Fencing Solutions

MasterHalco.com | 888-MH-Fence

Branch service centers are located throughout North America.

MH 046025 © 010/09

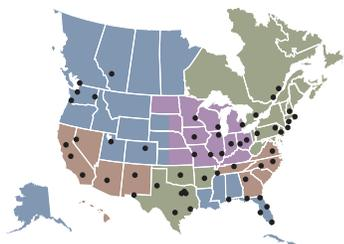

Available from:

